

**Normalprofil 1:50**  
Bergseitige Trockensteinmauer

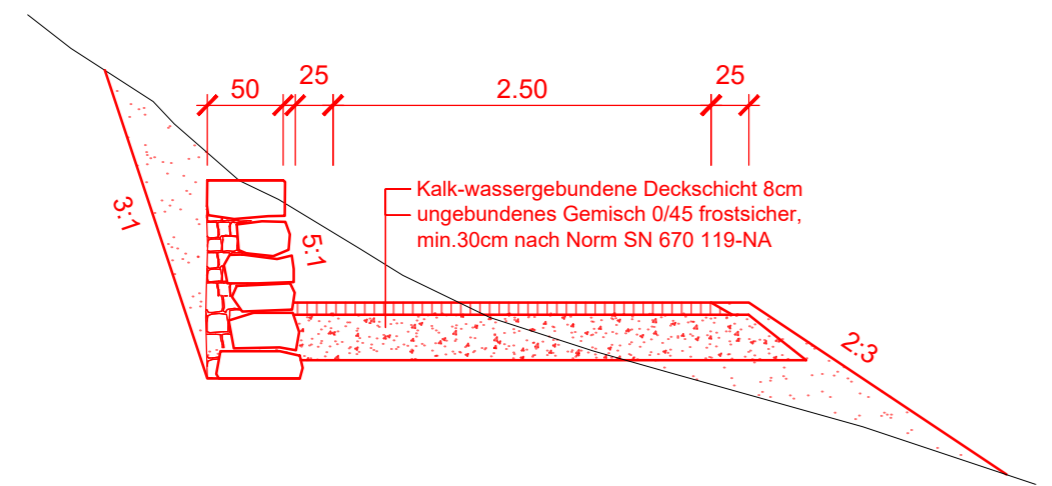

**Normalprofil 1:50**  
Talseitige Trockensteinmauer

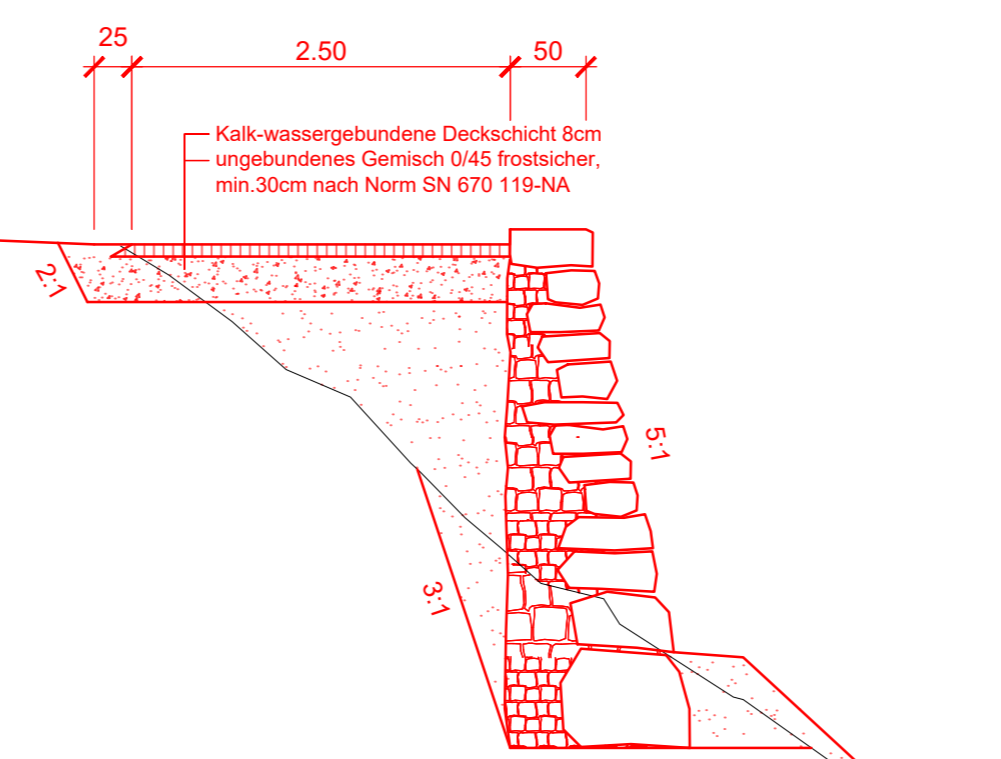

Änderungen:

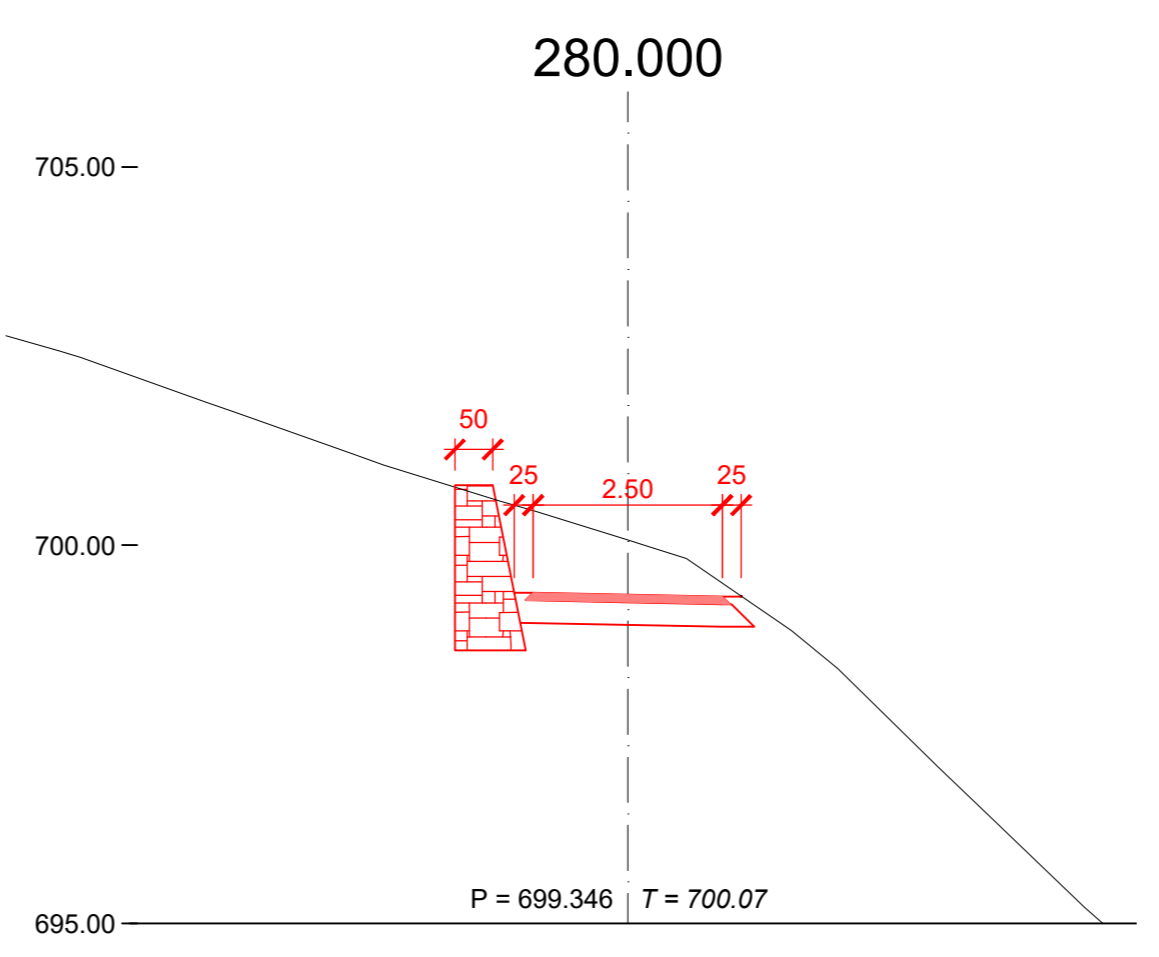
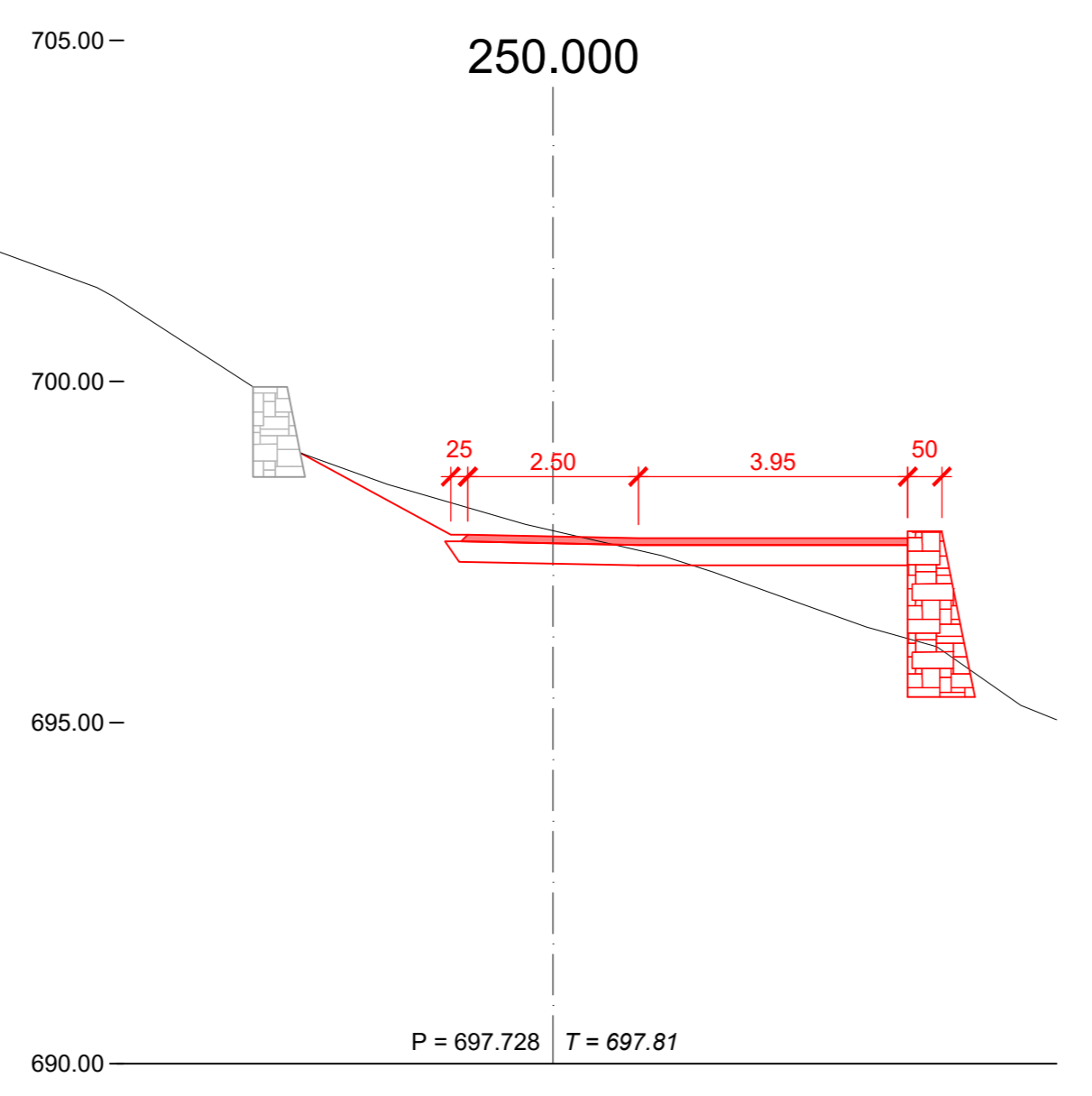
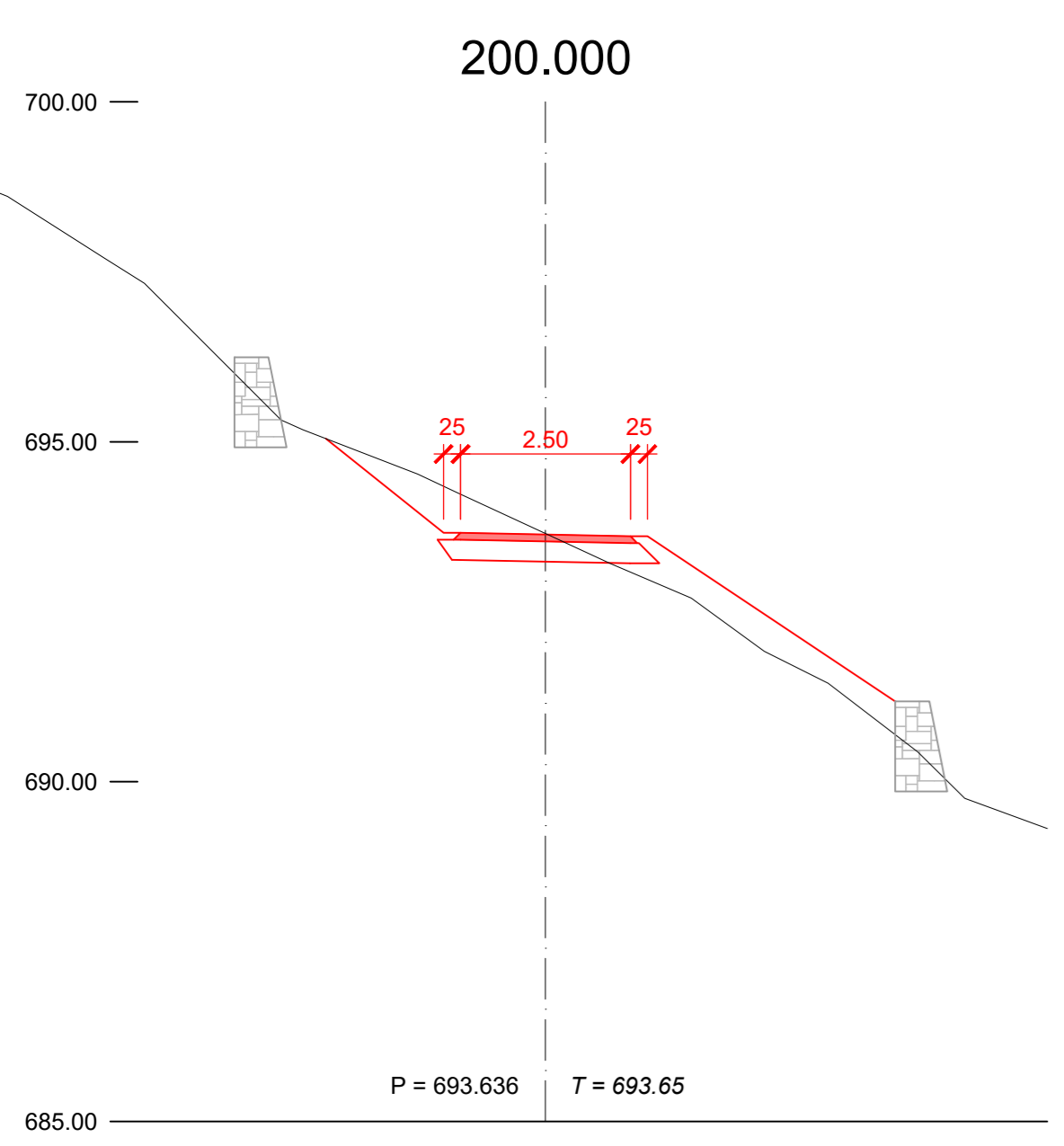
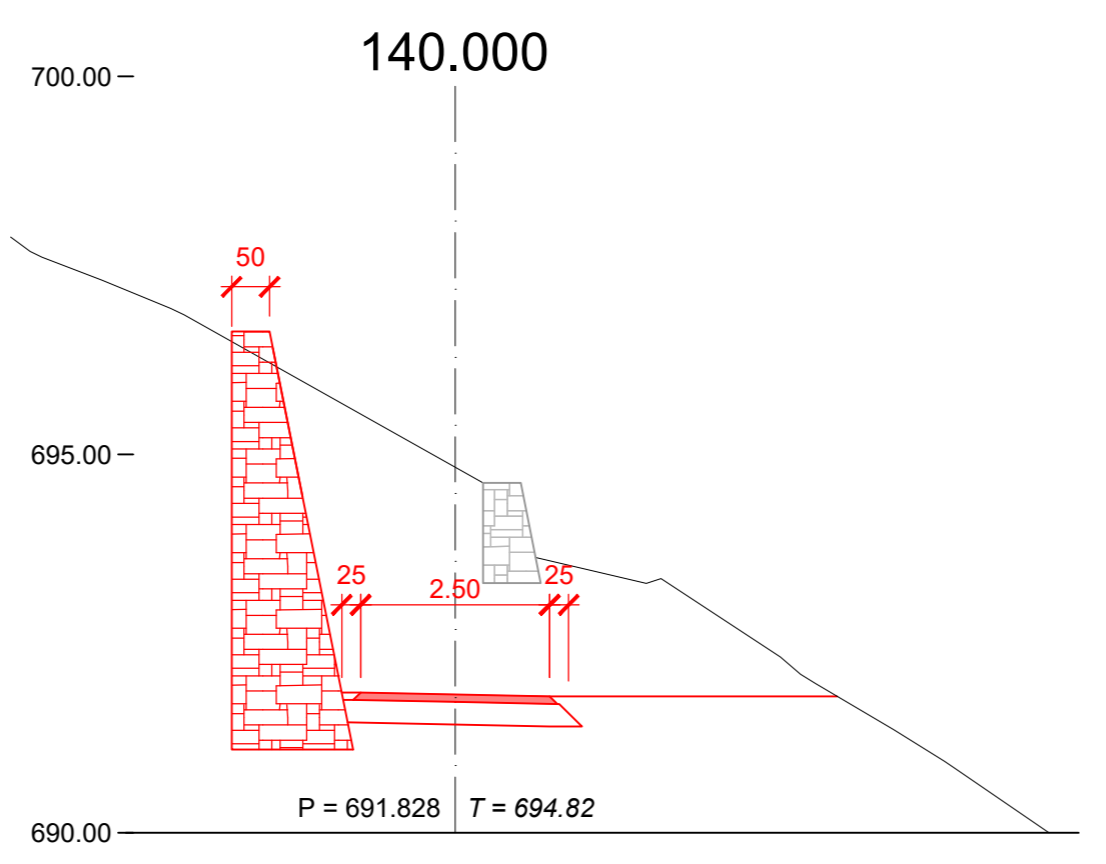
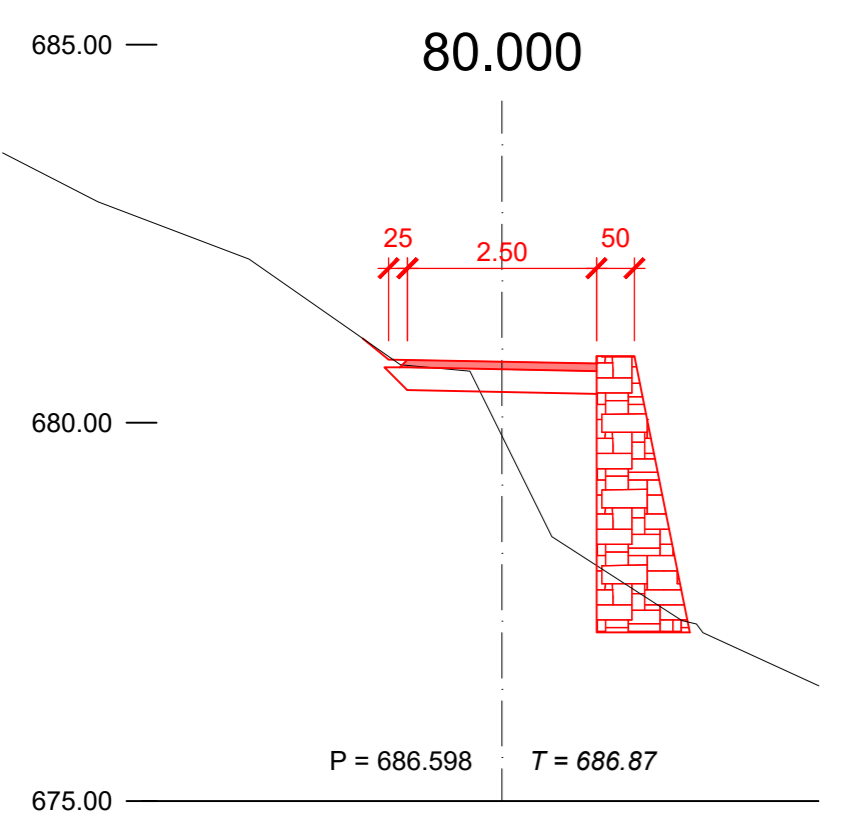
Bauherr:  
**Gemeinde Raron**

Projekt:  
**Erhaltung Rebberge und Trockenmauern Raron**

**Vorprojekt** **Beilage Nr. 8**

Erschliessung St. German Variante 4  
**Normalprofile, Querprofile**

Normalprofile 1:50, Querprofile 1:100

<b>965</b>		Plan Nr. 965-45-004-3				
Erstellung		Prüfung		Freigabe		Rev.
Datum	Visum	Datum	Visum	Datum	Visum	
16.05.2022	YS	16.05.2022	FL	16.05.2022	FL	
696/401	0.28m <sup>2</sup>	0965_45-001_Übersicht St.German Variante 3_1 Sit NP QP 2 LP.dwg				

**sbp** INGENIEURE  
Schneider - Bregy und Partner AG  
Ingenieure ETH/FH sia usic  
Bahnhofstrasse 58  
Postfach 60  
CH - 3942 Raron

**BINA Engineering SA**  
Turtmann / Siders / Visp